



Model: TC4

Commercial Connected Thermostat with Humidity and CO₂

Installation Guide



Before you start

Review all instructions before starting to avoid discovering or creating any issues during installation. This thermostat is designed to be installed on 24V AC systems only.

This thermostat is designed to be installed by a licensed professional.

A Pelican Gateway must be used with this thermostat. The thermostat cannot be configured or managed without the gateway. We recommend installing the gateway prior to installing this product.

Installation Location

NEVER INSTALL IN AN ENCLOSED METAL BOX OR ON A METAL SURFACE.

Install in a location where it can communicate with the Pelican wireless mesh network.

Install 48" to 60" from the floor in the room where it will be maintaining the temperature.

Install on an interior wall away from doors, filing cabinets, electrical equipment, or other metal objects.

Do not install on a metal surface or inside a metal enclosure.

Turn Off Power

Turn OFF the power to the equipment this thermostat is going to be wired to. Either power off at the circuit breaker panel or by turning off the master power at a local disconnect.

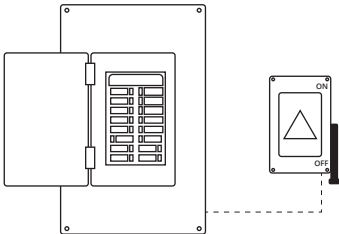

Replacing an Existing Wired Thermostat

Remove the cover from the old thermostat and either take a picture or label the wires as a guide for wiring the new Pelican thermostat.

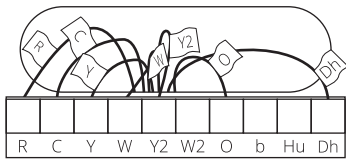

Uninstall the old thermostat and set aside.

Thermostat Location

This Pelican thermostat is designed to either mount flush on the wall or on a vertical 1-gang electrical box.

Choose a mounting location where the thermostat:

is at least 48" to 60" above the floor.

is on an interior wall.

where it can detect the temperature of the room it will be maintaining.

and is away from sun exposure or airflow drafts.

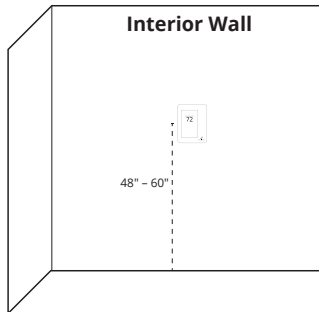

Air Blocking Shield

Before mounting the backplate to the wall, insert the airflow shield into the backplate to help prevent unusual airflows from affecting the thermostat's temperature accuracy.

Align the air shield with the backplate's center hole. It will only align in one orientation, never force it into place.

Press the shield into the back plate until it holds. Make sure the shield is fully inserted into the back plate for best results.

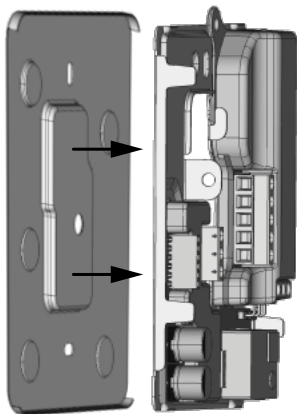

Run Wires into Thermostat Backplate

Pass the thermostat wire through the designated opening in the Air Shield.

While modifying the air shield is not recommended, if the wire cannot be easily pulled through the provided hole, you may carefully use a box cutter or scissors to slightly enlarge the opening for better flexibility.

Cuts can be made, as shown to the right, with minimal effect on the integrity of the air shield.

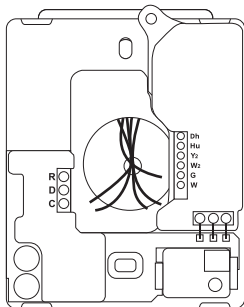

Limited Wire Installation

In some installations, there may be limited wiring between the thermostat and the HVAC equipment. The included Wiring Module allows control of the HVAC system without the need to install new or additional wires.

This setup requires at least three (3) wires between the thermostat and the Wiring Module (unshielded wire is acceptable).

It supports a maximum distance of 500 feet between the Wiring Module and the thermostat.

Step 1: Remove the Wiring Module from the thermostat's back plate.

Loosen the (R), (C), and (D) terminals on the Wiring Module. Gently slide the Wiring Module upwards, away from the three-pin connector, to remove it.

Step 2: Install the Wiring Module in the HVAC equipment.

Locate the HVAC equipment's control board. Using new wire, connect the Wiring Module's terminals to the corresponding low-voltage input terminals on the HVAC control board.

Refer to the wiring diagrams on Pages 8–17 for the most common thermostat wiring.

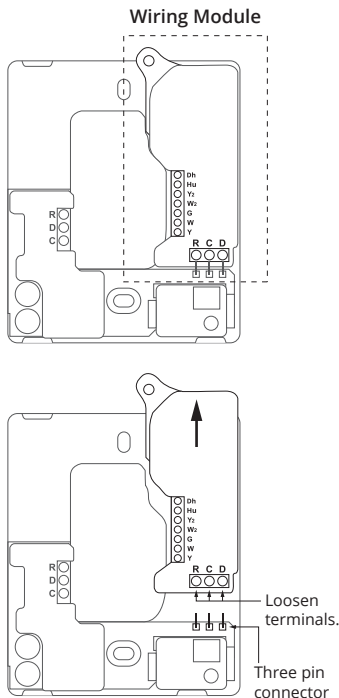

Use a sheet metal screw to secure the Wiring Module.

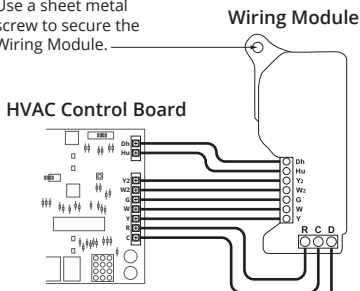

Step 3: Connect Wiring Module to thermostat.

Using the existing wires, connect the (R), (C), and (D) terminals from the Wiring Module to the corresponding (R), (C), and (D) terminals on the thermostat's back plate.

Wiring Module mounted at control board.

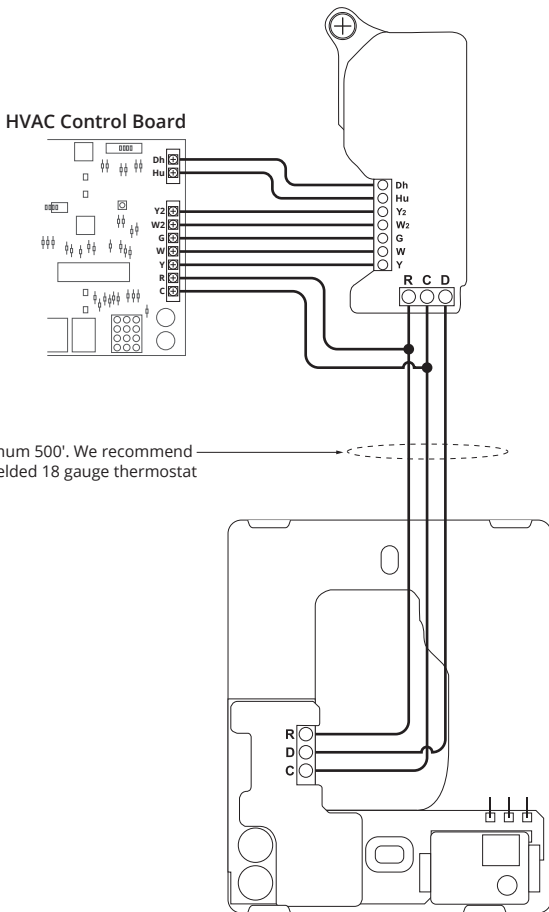

Thermostat back plate mounted in room.

Attach the Display

Before attaching the display, write down the serial number displayed on the screen. This number will be needed when configuring the thermostat.

Align the display with the back plate's alignment pins, then press it into the back plate until it clicks into place.

Turn on the power to the HVAC equipment connected to the thermostat.

If your Pelican thermostat does not power on, refer to page 18 for troubleshooting.

For instructions on setting up Conventional or Heat Pump control, refer to page 20.

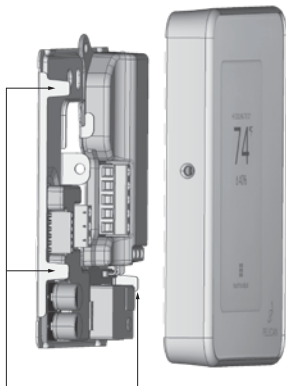

there are three (3) alignment pins found on the left and right sides of the base plate.

Optional: Tamper Resistant Lock

The thermostat has an internal locking mechanism that secures the display to the back plate, preventing unauthorized access to the power and thermostat wires.

To engage the lock, assemble the thermostat and insert a 1/8" flat-head screwdriver into the hole on the left side of the thermostat. Push in slightly and turn 1/4 turn clockwise until it reaches the stop. Then, remove the screwdriver.

To disengage the lock, insert a 1/8" flat-head screwdriver into the same hole and turn 1/4 turn counter-clockwise until it reaches the stop. Remove the screwdriver.

Do **NOT** attempt to force the display off the back plate, as this could cause damage.

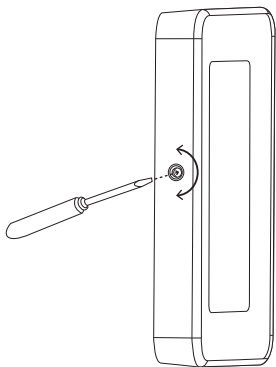

Wiring Guides

For conventional heating and cooling systems, see pages 8 - 9

For heat pumps, see pages 10 - 11

For two-pipe fan coils, see pages 12 - 13

For four-pipe fan coils, see pages 14 - 15

For humidity control, see page 16

For zone damper control, please see the separate installation guide for Zone Damper Control.

For installations not covered in this guide, **STOP INSTALLING THE THERMOSTAT** and contact Pelican Sales Engineering Support for further assistance at 888-512-0490.

24 VAC Terminal Block Designations

Conventional

DATA	D
COMMON	C
24 VAC POWER	R

COOL STAGE 1	Y
HEAT STAGE 1	W
FAN	G
HEAT STAGE 2	W2
COOL STAGE 2	Y2
HUMIDIFY	Hu
DEHUMIDIFY	Dh

Heat Pump

DATA	D
COMMON	C
24 VAC POWER	R

COMPRESSOR STAGE 1	Y
REVERSING VALVE (O/b)	W
FAN	G
AUXILIARY HEAT	W2
COMPRESSOR STAGE 2	Y2
HUMIDIFY	Hu
DEHUMIDIFY	Dh

Two-Pipe Fan Coil

DATA	D
COMMON	C
24 VAC POWER	R

VALVE OPEN	Y
UNUSED	W
FAN	G
AUXILIARY HEAT	W2
VALVE CLOSE	Y2
HUMIDIFY	Hu
DEHUMIDIFY	Dh

Four-Pipe Fan Coil

DATA	D
COMMON	C
24 VAC POWER	R

CHILLED VALVE OPEN	Y
HOT VALVE OPEN	W
FAN	G
HOT VALVE CLOSE	W2
CHILLED VALVE CLOSE	Y2
HUMIDIFY	Hu
DEHUMIDIFY	Dh

Conventional Heating and Cooling Systems (Up to 2 stages each)

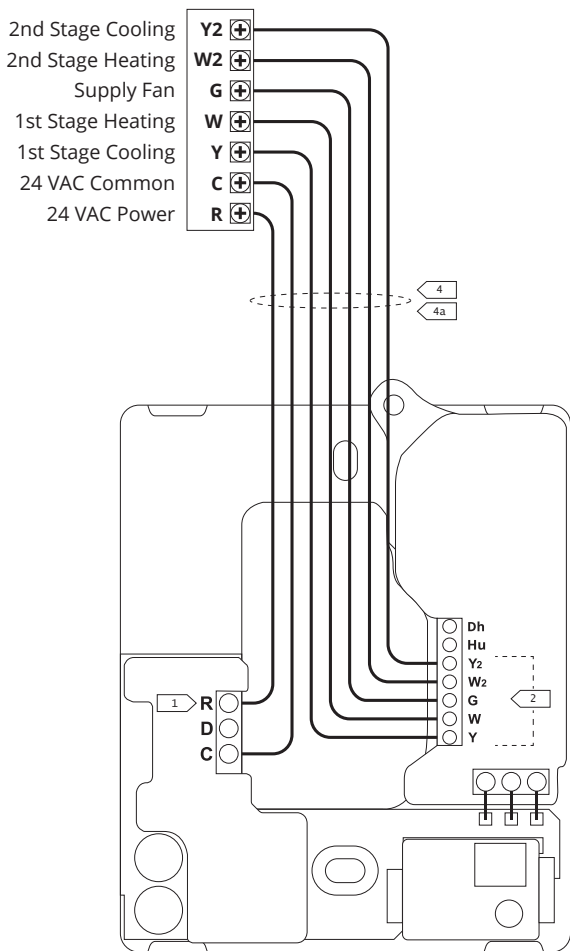

Notes can be found on page 18.

Conventional Heating and Cooling Systems (Up to 1 stages cool, 2 stages heat, and 2 speed fan)

- High Speed Supply Fan
- 2nd Stage Heating
- Low Speed Supply Fan
- 1st Stage Heating
- 1st Stage Cooling
- 24 VAC Common
- 24 VAC Power

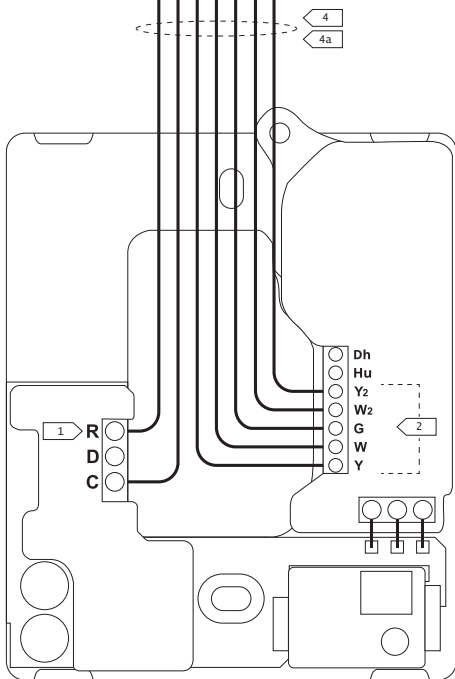

Notes can be found on page 18.

Heat Pump Systems (Up to 2 stages each and Auxiliary/Emergency Heat)

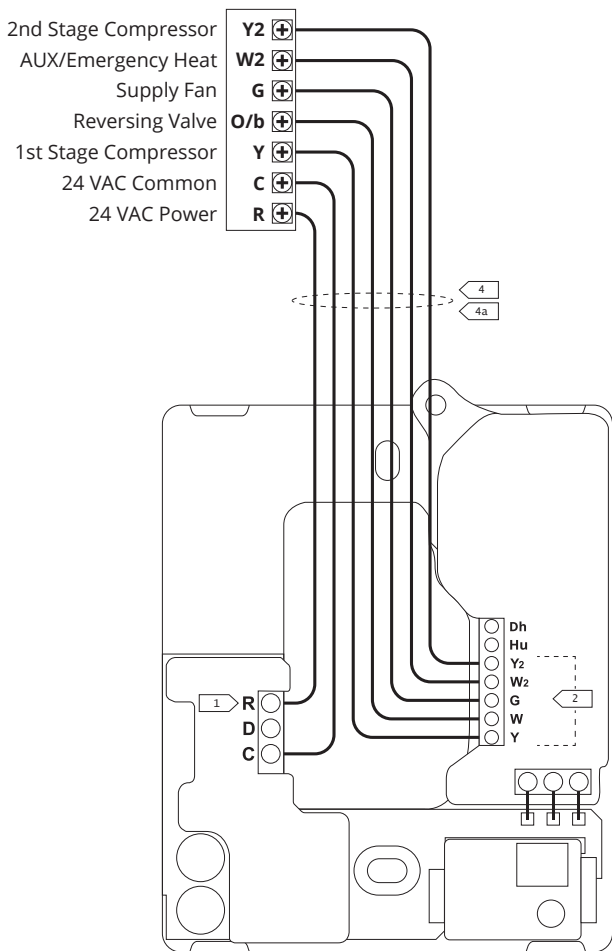

Notes can be found on page 18.

Heat Pump Systems

(Up to 1 stages each, 2 speed fan, and Auxiliary/Emergency Heat)

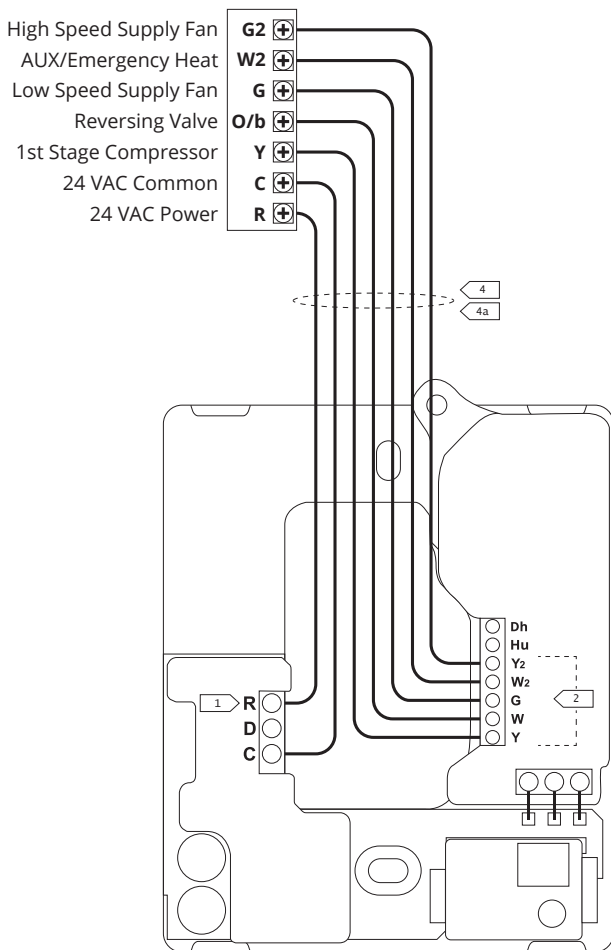

Notes can be found on page 18.

Two-Pipe Fan Coils* (Power-open/spring-return or floating water valve)

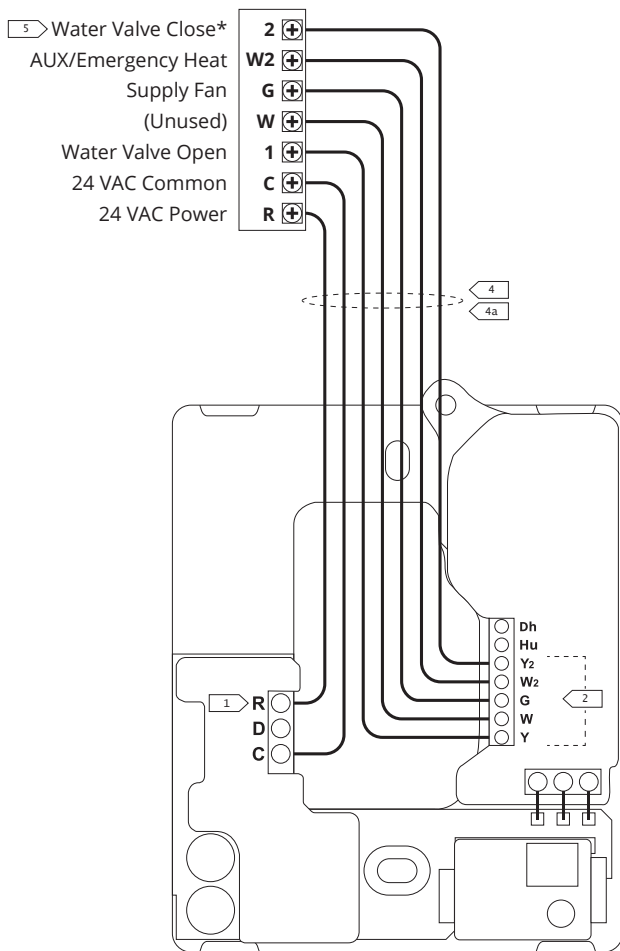

Notes can be found on page 18.

*Contact Pelican Technical Support for thermostat configuration assistance.

Two-Pipe Fan Coils* (Power-open/spring-return water valve and 2 speed fan)

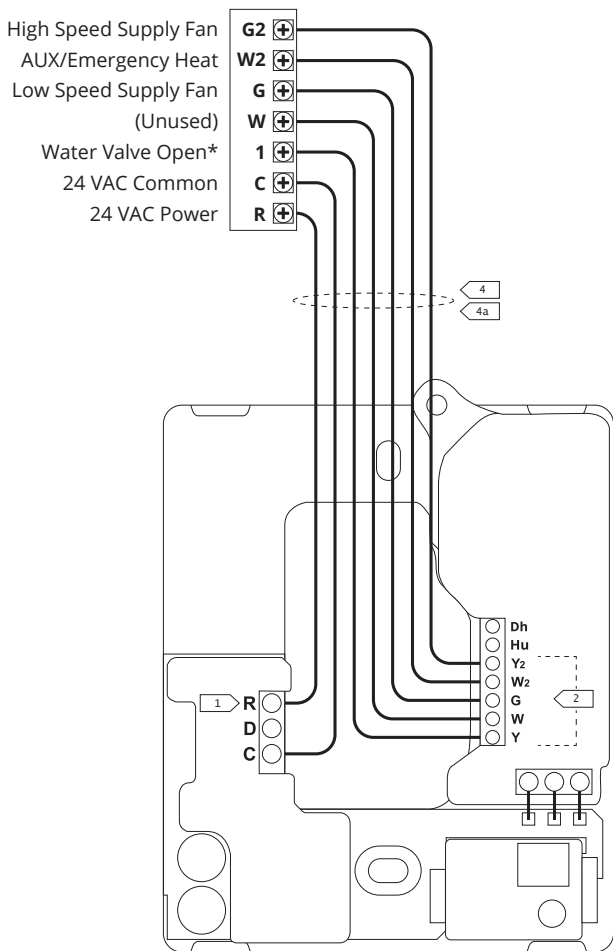

Notes can be found on page 18.

*Contact Pelican Technical Support for thermostat configuration assistance.

Four-Pipe Fan Coils (Power-open/spring-return or floating water valve*)

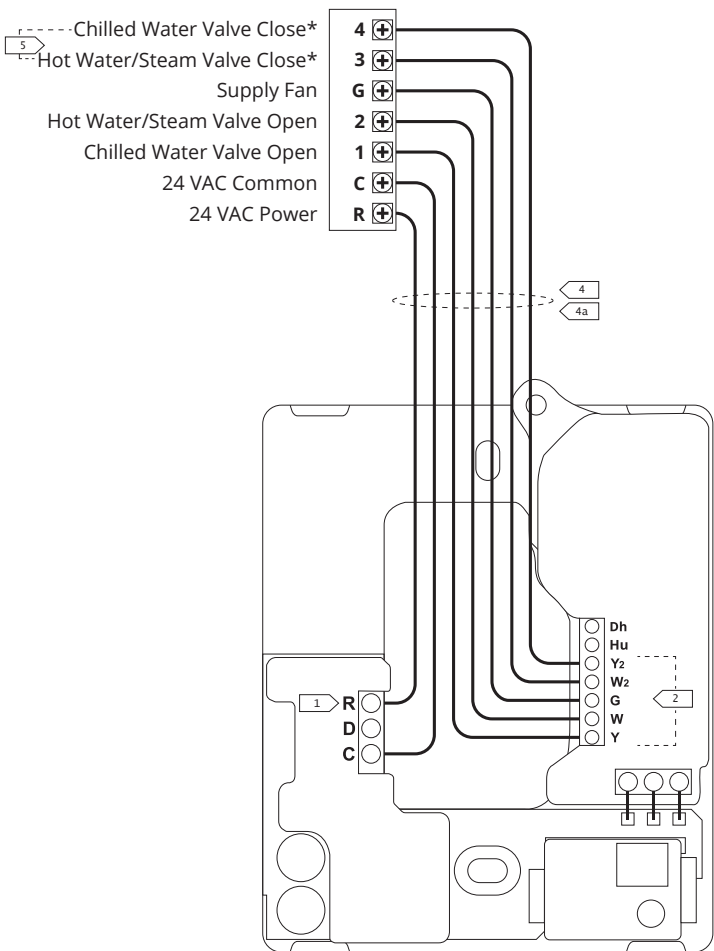

Notes can be found on page 18.

*Contact Pelican Technical Support for thermostat configuration assistance.

Four-Pipe Fan Coils (Power-open/spring-return water valves and 2 speed fan)

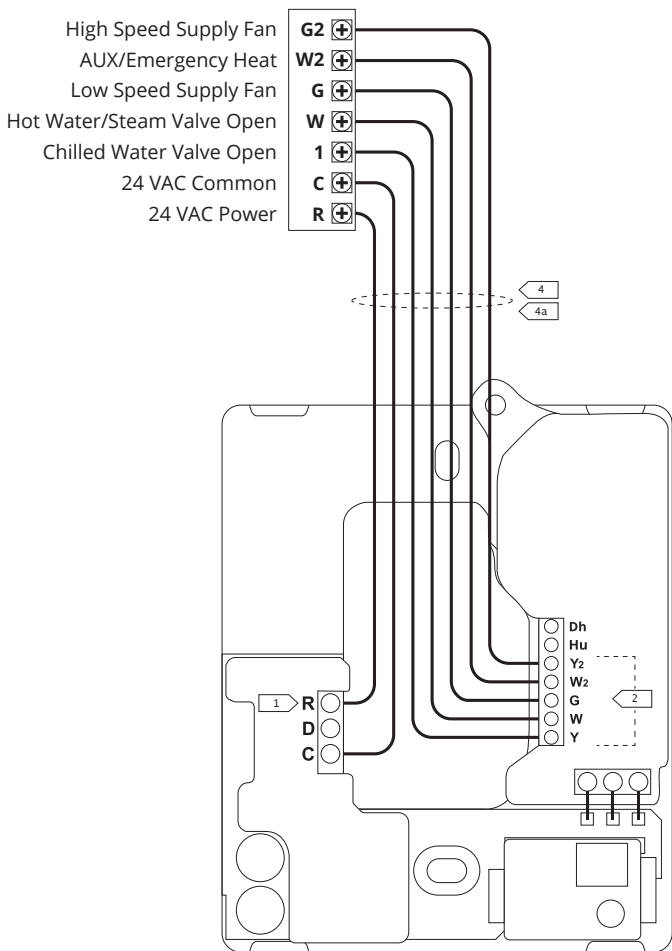

Notes can be found on page 18.

Humidity Control (Humidify and/or Dehumidify)

Dehumidifier/Hot Gas Bypass Enable
Humidifier Enable

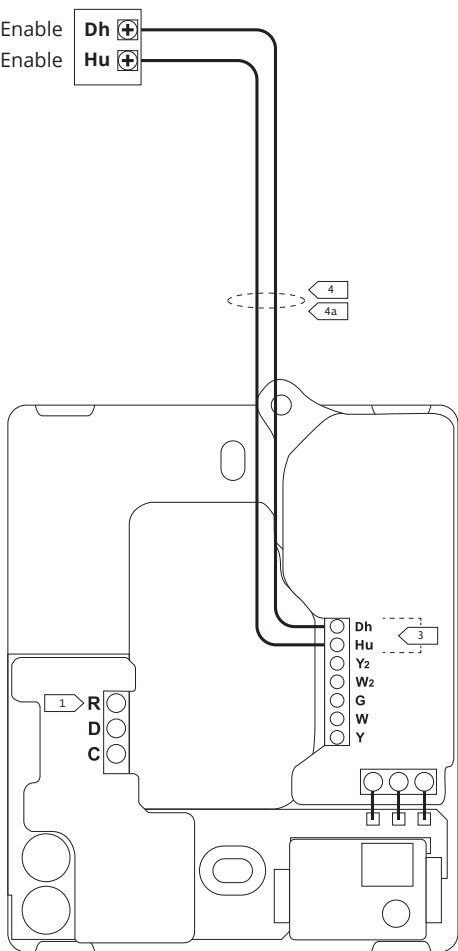

Notes can be found on page 18.

Notes

- 1 Connect to 24 VAC class 2 circuits only.
- 2 Latching relays are rated for 24 VAC @ 2 amps continuous load.
- 3 Latching relays are rated for 24 VAC @ 1 amp continuous load.
- 4 All wire to be installed by customer in accordance with local electrical codes.
- 4a Use 18 gauge unshielded thermostat wire.
- 5 Only found for actuators that are 24 VAC floating type.

Troubleshooting

If the Pelican thermostat does not power on, check the following:

1. Check that all wires are properly inserted into the terminal blocks at the thermostat and at the HVAC equipment. Lightly pull on the wires to make sure they are not loose.
2. Use a multi-meter to ensure that 24 VAC power is being supplied by HVAC equipment. If 24 VAC is not found, check that the master power has been turned back on for the HVAC equipment or verify that the HVAC electrical breaker has not tripped. If the breaker has tripped contact a Licensed Professional to assist, otherwise damage can occur to the equipment or you can get hurt.
3. Use a multi-meter to ensure that 24 VAC power is found at the thermostat. If 24 VAC was not found, but is found at the HVAC equipment, check for loose or spliced wires.
4. If you used the Wiring Module, use a multi-meter to ensure that 24 VAC power is found at the Wiring Module and the thermostat. Check that the (R), (C), and (D) wires are properly connected between the Wiring Module and the thermostat.

If the thermostat still does not power on, contact Pelican technical support for further assistance at 888.512.0490.

If the Pelican thermostat does not show up on the Pelican App, check the following:

1. Check the thermostat upper right hand corner.

If you see this symbol  then the thermostat is unable to connect to your Pelican Wireless Mesh Network.

- Finish installing all your other Pelican thermostats and/or devices.
- Verify your Pelican thermostat is not in a metal enclosure and that there are no metal structures/objects surrounding it. Wireless can NOT communicate through metal.

2. If you see this symbol  then the thermostat is connected to your Pelican Wireless Mesh Network, but your Pelican Gateway is unable to reach the Internet.

- Check your Pelican Gateway to verify it is installed, powered on, and has Internet connection.

If you are unable to get the thermostat to connect to the wireless mesh network or Internet, contact Pelican technical support for further assistance at 888.512.0490.

Thermostat Info Page

To access the thermostat info, touch *Touch to adjust* and then press the  icon in the upper right hand corner of the screen.

Serial Number

Is the unique identifier for this thermostat. Correlate this number on the Pelican App to configure and name this thermostat.

Thermostat Name:

This is a custom identifier for this thermostat. The thermostat is named using the Pelican App.

Configuration:

This identifies the thermostat's current configuration and provides the ability to change this configuration between Conventional and Heat Pump. This can also be accomplished through the Pelican App where other thermostat configurations are found.

Humidity Setting:

If humidity control is enabled, the thermostat's humidity set-point will be shown under this heading. The set-point can be adjusted by touching the adjust button. Otherwise, if humidity control is disabled, Off will be displayed below this heading. Humidity control configurations can be found in the Pelican App where other thermostat configurations are found.

Model Number:

This is the model number of this thermostat.

Alarm Notifications:

If there are any icons in the upper right hand corner of the thermostat, the Info page will identify the issue detected. Follow the troubleshooting guide on page 16 for assistance.

Thermostat Conventional/Heat Pump Configuration Page

Within the first 5 minutes after the thermostat was last powered On, the thermostat will allow you to set it to Conventional or Heat Pump control. This can also be done at anytime through the Pelican App.

To access the configuration page, select *Touch to adjust* and then press the  icon in the upper right hand corner of the screen.

Under *Configuration*, you will see the current control setting (default configuration is *Conventional*).

To change the configuration, press the *change* button to the right of *Configuration*. Then touch *Conventional*, *Heat Pump (O)*, or *Heat Pump (B)* and press *Save* at the bottom of the screen to set the new configuration.

If you do NOT want to change the thermostat's configuration, press *Cancel* at the bottom of the screen.

CO2 Sensor Calibration

The CO2 sensor is factory calibrated to be accurate within plus or minus 50 ppm +3% at a 600 and 1000 ppm concentration when measured at sea level @ 25°C.

The CO2 sensor auto-corrects drift using built-in self-correcting logic. The auto baseline correction period is 24h+7 days. After 24 hours of continuous power, the lowest CO2 concentration measurement value is recorded and regarded as baseline (400 ppm). The sensor enters regular 7 day correction cycles and auto-calibrates every 7 days. Allow for up to two (2) calibration cycles (2 weeks) for sensor accuracy to establish.

